

The ibidi product family is comprised of a variety of μ-Slides and μ-Dishes, which have all been designed for high-end microscopic analysis of fixed or living cells.

The glass bottom versions of the μ-Slides and μ-Dishes are especially designed for TIRF and single molecule applications. The μ-Dish ^{35mm, high} Glass Bottom Grid-50 allows you to perform high resolution microscopy in a 35 mm Petri-dish with 12 mm walls. The standard height allows convenient liquid handling. The lid can be closed to hinder evaporation during long term experiments.

The Grid-50 is a grid structure for relocating events on a glass coverslip. It provides 4 × 400 distinguishable observation squares of 50 μm edge length. The grid is clearly visible by phase contrast microscopy and imprinted into a microscopy coverslip. The outer dimensions and other parameters are identical to ibidi μ-Dishes.

Material

The μ-Dish ^{35mm, high} Glass Bottom Grid-50 is made of a standard μ-Dish ^{35mm, high} but with a glass coverslip bottom. It is not possible to detach the bottom. The μ-Dishes are not autoclavable since they are temperature stable only up to 80°C / 175°F.

Optical Properties ibidi Glass Bottom

Refractive index n_D	1.523
Abbe number	55
Thickness	No. 1.5H (selected quality 170 μm, ± 5 μm)
Material	Schott borosilicate glass, D 263M

Attention!

Be cautious when handling μ-Slides and μ-Dishes with glass bottom! The glass coverslip is very fragile and might break easily. Handle with care to avoid physical injury and damage to devices through leakage of the medium.

Shipping and Storage

The μ-Slides, μ-Dishes and μ-Plates are sterilized and welded in a gas-permeable packaging. The shelf life under proper storage conditions (in a dry place, no direct sunlight) is listed in the following table.

Conditions

Shipping conditions	Ambient
Storage conditions	RT (15-25°C)

Shelf Life of Different Surfaces

ibiTreat, Glass Bottom, ESS	36 months
Collagen, Poly-Lysine	18 months
Fibronectin	4 months

Characteristics of the Grid

The Grid-50 is made of small grooves that are imprinted into a microscopy coverslip. The structure is imprinted on the side on which cells are growing. Cells and grid are in one focal plane. There is no reported effect on cell growth, coating protocols, or surface properties. Proliferation and cell behavior is comparable to standard non-gridded glass coverslips. Washing steps (e.g. with PBS) before cell seeding can remove glass dust which is advantageous for direct cell growth on the surface.

Please also refer to the instructions of ibidi μ-Dishes glass bottom for information on surfaces, coatings, and cell seeding.

The grooves are 5 μm (± 1 μm) wide and approximately 5 μm deep. Cells can grow in the grooves as well. We recommend using objective lenses 20× or higher.

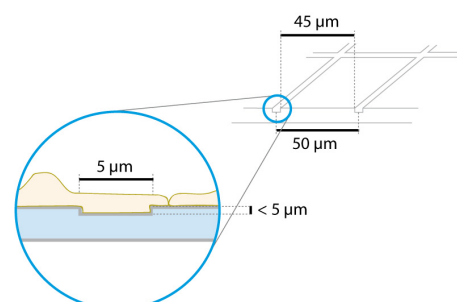

Geometry of the Grid-50

Geometry of the Grid-50	
Number of squares	4 x 400
Repeat distance	50 μ m
Groove width	5 μ m (\pm 1 μ m)
Groove depth	< 5 μ m

There are four grids numbered from A to D. Each consists of four major squares which are separated in 10 x 10 observation fields and indicated by letters and numbers ranging from:

- A to K (J not used) and 1 to 10
- A to K (J not used) and 11 to 20
- L to U and 1 to 10
- L to U and 11 to 20

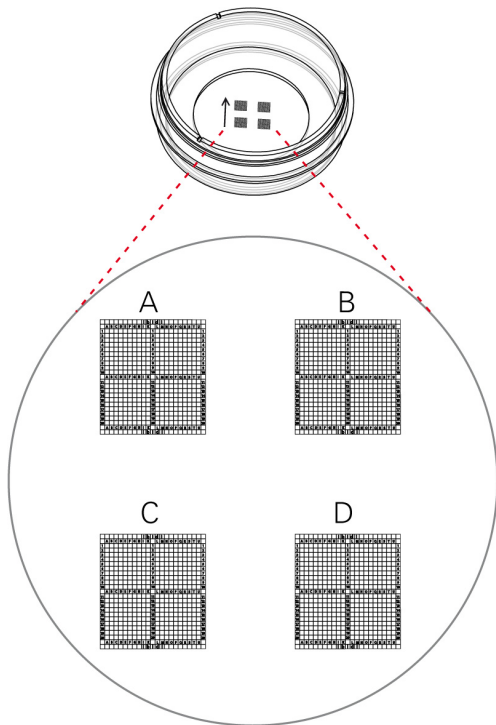

There are four grids numbered from A to D.

4 X 10 x 10 squares

A

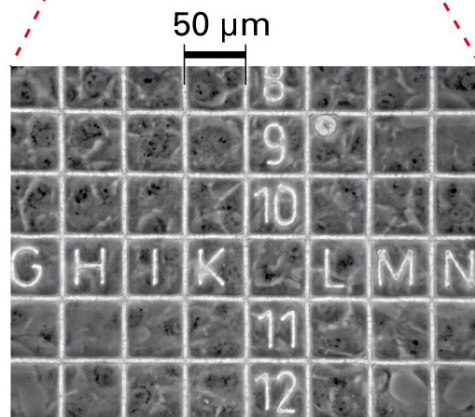
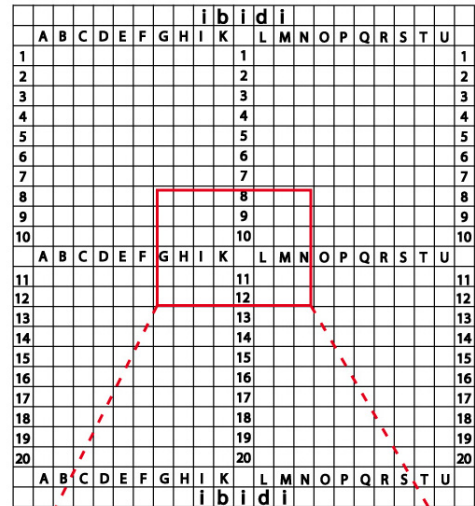

Microscopic image of the grid with rat fibroblast cells (20x objective lens phase contrast).

Using The Lid

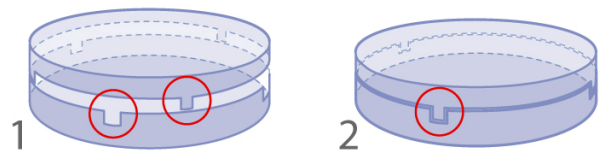

1. open position, easy opening
2. close position, for long term studies, minimal evaporation

Surface and Coating

The μ-Dish^{35mm, high} Glass Bottom Grid-50 is manufactured with an uncoated glass coverslip. Washing steps (e.g. with PBS) before cell seeding can remove glass dust which is advantageous for direct cell growth on the surface.

Protein coatings increase direct cell growth of adherent cells. Specific coatings on glass are possible following this protocol:

- Prepare your coating solution according to the manufacturer's specifications or reference. Prepare your μ-Dish. Adjust the concentration to a coating area of 4.2 cm² and 400 μl.
- Apply 400 μl into the growth area. Make sure that the entire bottom is covered with liquid easily tilting or shaking the μ-Dish. Put on the lid and leave at room temperature for at least 30 minutes.
- Aspirate the solution and wash. Optionally, let dry at room temperature.

Detailed information about coatings is provided in Application Note 08 "Cell culture coating".

Seeding Cells

Depending on your cell type, application of a 4–9 × 10⁴ cells/ml suspension should result in a confluent layer within 2–3 days.

- Trypsinize and count cells as usual. Dilute the cell suspension to the desired concentration.
- Apply 400 μl cell suspension into the inner well of the μ-Dish. Avoid shaking as this will result in inhomogeneous distribution of the cells.
- After cell attachment add additionally 1.6 ml of pure medium to ensure optimal grow conditions.
- Cover the μ-Dish with the supplied lid. Incubate at 37°C and 5% CO₂ as usual.

We recommend not to fill more than the indicated total volume into the μ-Dish^{35mm, high} Glass Bottom Grid-50 in order to avoid the liquid contacting the lid.

Undemanding cells can be left in their seeding medium for several days and grow to confluence there. However, best results are achieved when the medium is changed every 2–3 days. Carefully aspirate the old medium and replace it by up to 2 ml fresh medium.

Tip:

You can stack the μ-Dishes to save space in your incubator. This will not affect cell growth. We recommend making batches with up to 6 μ-Dishes, due to stability reasons. Placing the μ-Dishes into larger Petri dishes simplifies transport and prevents evaporation, heat loss, and contamination when the incubator is opened.

Preparation for Cell Microscopy

To analyze your cells no special preparations are necessary. Cells can be observed live or fixed directly in the μ-Dish preferably on an inverted microscope. You can use any fixative of your choice. The μ-Dish material is compatible with a variety of chemicals, e.g. Acetone or Methanol. Further specifications can be found at www.ibidi.com. Due to the thin bottom high resolution microscopy is possible.

For optimal results in fluorescence microscopy and storage of stained probes, ibidi provides a mounting medium optimized for μ-Dishes and μ-Slides (ibidi Mounting Medium, 50001).

Minimizing Evaporation

Using the μ-Dish with a closed lid, the evaporation in an incubator system with 37°C and 95% humidity is around 1% per day. Using the μ-Dish with a closed lid in a 37°C heating system with low humidity (between 20% and 40%), the evaporation is around 10% per day. For reducing the evaporation down to 1% per day in all systems, we recommend sealing the lid with ibidi Anti-Evaporation Oil (50051).

Immersion Oil

When using oil immersion objectives, use only the immersion oils specified in the table. The use of a non-recommended oil could lead to the damage of the plastic material and the objective.

Company	Product	Ordering Number
Zeiss	Immersion 518 F	(Zeiss) 444960
Zeiss	Immersion W 2010	(Zeiss) 444969
Leica	Immersion liquid	(Leica) 11513859

μ-Dish ^{35mm} Grid Family

μ-Dish ^{35mm, high} Grid-500

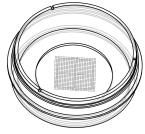

Cat. No.	Description	Characteristics
81166	μ-Dish ^{35mm, high} ibiTreat Grid-500 : ø 35 mm, high wall (2 ml volume), #1.5 polymer coverslip, tissue culture treated, grid repeat distance 500 μm	hydrophilic, sterilized
81161	μ-Dish ^{35mm, high} Uncoated Grid-500 : ø 35 mm, high wall (2 ml volume), #1.5 polymer coverslip, grid repeat distance 500 μm	hydrophobic, sterilized

μ-Dish ^{35mm, low} Grid-500

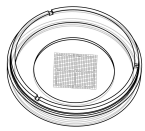

Cat. No.	Description	Characteristics
80156	μ-Dish ^{35mm, low} ibiTreat Grid-500 : ø 35 mm, high wall (800 μl volume), #1.5 polymer coverslip, tissue culture treated, grid repeat distance 500 μm	hydrophilic, sterilized
80151	μ-Dish ^{35mm, low} Uncoated Grid-500 : ø 35 mm, high wall (800 μl volume), #1.5 polymer coverslip, grid repeat distance 500 μm	hydrophobic, sterilized

μ-Dish ^{35mm, high} Glass Bottom Grid-500

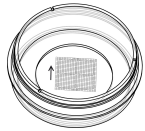

Cat. No.	Description	Characteristics
81168	μ-Dish ^{35mm, high} Glass Bottom Grid-500 : ø 35 mm, high wall (2 ml volume), #1.5H (170 ±5 μm) D 263 M Schott glass, grid repeat distance 500 μm	sterilized

μ-Dish ^{35mm, high} Glass Bottom Grid-50

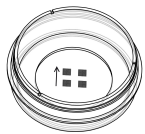

Cat. No.	Description	Characteristics
81148	μ-Dish ^{35mm, high} Glass Bottom Grid-50 : ø 35 mm, high wall (2 ml volume), #1.5H (170 ±5 μm) D 263 M Schott glass, grid repeat distance 50 μm	sterilized

For research use only!

Further technical specifications can be found at www.ibidi.com. For questions and suggestions please contact us by e-mail info@ibidi.de or by telephone +49 (0)89/520 4617 0. All products are developed and produced in Germany.

© ibidi GmbH, Am Klopferspitz 19, 82152 Martinsried, Germany.