

Instruction Manual

ibidi Heating System 4 Slides – Silver Line

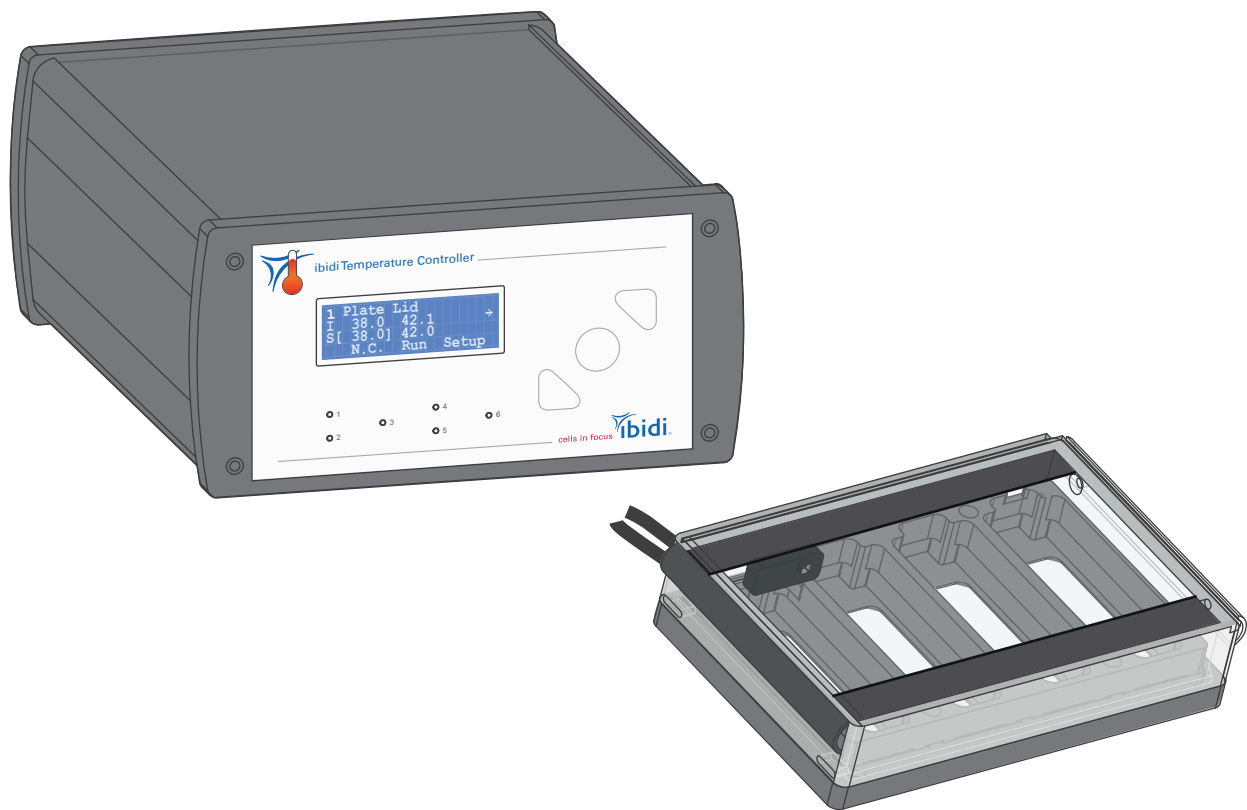

12130 ibidi Heating System 4 Slides – Silver Line



Instructions & Software



ibidi.com/stagetop

Contact

ibidi GmbH

Lochhamer Schlag 11
82166 Gräfelfing
Germany

Phone: +49 89 / 520 46 17 - 0

Fax: +49 89 / 520 46 17 - 59

E-mail: info@ibidi.de

Web: ibidi.com

Contents

1	Preamble	6
1.1	Introduction	6
1.2	Safety Symbols	6
1.3	Nomenclature	7
1.4	Specifications	7
1.5	Disclaimer	9
1.6	Safety Considerations	9
1.7	Limited Warranty	11
1.8	Transporting the ibidi Heating System 4 Slides	11
1.9	Repairing the ibidi Heating System 4 Slides	12
1.10	Waste Disposal – WEEE/RoHS Compliance Statement	12
1.10.1	EU Directive WEEE	12
1.10.2	EU Directive RoHS	12
1.11	Regulatory Statement	13
2	Intended Use	14
3	Principle	14
4	Equipment	16
4.1	Components of the ibidi Heating System 4 Slides	16
4.2	Stage Top Incubator Overview	17
4.3	ibidi Temperature Controller – Silver Line	18
4.4	Heated Plate and Magnetic Holder	19
4.5	Heated Lid	20
4.6	Cable Clip for Optional Use	21
4.7	Optional Equipment	22
4.7.1	Objective Heater Universal – Silver Line	22
5	Operation	25
5.1	Installation and Connection of the Components	25
5.2	Start Operation of the ibidi Heating System 4 Slides	26
5.3	Setting Parameters in the Front Display	26
5.3.1	Run/Stop Mode	27
5.3.2	Setup Menu	28
5.4	Temperature Adjustment in the Sample	29
5.5	Sample Preparation	30
5.6	Using ibidi Heating System 4 Slides with the Objective Heater Universal – Silver Line	31
5.6.1	Installation and Connection of the Objective Heater Universal – Silver Line	31
5.6.2	Temperature Adjustment of the Objective Heater Universal – Silver Line	33

6	IncuControl Software	35
7	Maintenance	36
7.1	Disinfection and Cleaning	36
7.2	Influence of Ambient Temperature and Ventilation	36
8	Troubleshooting	37
8.1	Focus not Stable	37
8.2	Evaporation too High	37
8.3	Condensation Inside the Stage Top Incubator	37

1 Preamble

1.1 Introduction

This manual is your guide for using the ibidi Heating System 4 Slides – Silver Line for cell culture experiments on an optical microscope. It instructs first-time users on how to use the instrument, and serves as a reference for experienced users.

Before using the ibidi Heating System 4 Slides – Silver Line, please read this instruction manual carefully and make sure that the contents are fully understood. This manual should be easily accessible to the operator at all times during instrument operation. If this manual gets lost, see the online version on [ibidi.com](https://www.ibidi.com) or request a replacement via techsupport@ibidi.com.

To ensure safe operation, the ibidi Heating System 4 Slides – Silver Line must only be operated with the supplied components and according to the instruction manual.

For Research Use Only! Not for use in diagnostic procedures.

1.2 Safety Symbols

Note that the signal words **WARNING**, **CAUTION** and **NOTE** have specific meanings in this manual. Do not proceed beyond a signal word until you have performed the indicated actions. Warning messages in the text are displayed in a gray shaded box. Please see Section 1.6 for general safety considerations.



WARNING – A potentially hazardous situation which, if not avoided, could result in serious injury or even death.



CAUTION – A potentially hazardous situation which, if not avoided, could result in minor or moderate injury. It is also used to alert against damaging the equipment or the instrument.



NOTE – Additional information to help achieve optimal instrument and assay performance.

Symbols on the product identification label and back panel of the device:



CE Marking: This symbol indicates the product's compliance with EU legislation.



UKCA Marking: This symbol indicates the product's compliance with UK legislation.



This label is positioned on the back of the device and prompts you to read the manual before using the device.



Product disposal: The symbol indicates that this product must be recycled/disposed of separately from other household waste. See page 12 for details.

1.3 Nomenclature

The ibidi Heating System 4 Slides – Silver Line consists of the following main components:



*ibidi Temperature Controller
– Silver Line*

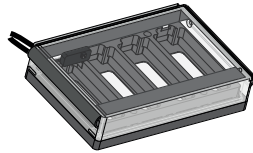

Incubation Chamber

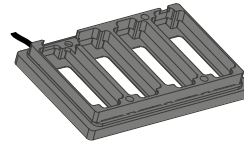

Heated Plate

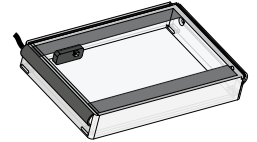

Heated Lid

Where adequate, the ibidi Heating System 4 Slides – Silver Line is hereafter abbreviated and referred to as ibidi Heating System 4 Slides in body text and figure captions. The ibidi Temperature Controller – Silver Line is hereafter abbreviated and referred to as Temperature Controller, where adequate.

1.4 Specifications

Only operate the ibidi Heating System 4 Slides in the range of the specifications given in table 1 below.

Table 1: Specifications of the ibidi Heating System 4 Slides – Silver Line

Electrical Specifications Power Supply	
Protection class	I
International protection marking (IEC 60529)	IP 20
Overvoltage category	II
Pollution degree	2
Input voltage and current	AC 100–240 V, 50/60 Hz, 2 A, 36–40 W
Output voltage and current	DC 24 V, 6.67 A, 160 W
Electrical Specifications ibidi Temperature Controller – Silver Line	
Protection class	III
Ingress protection rating	IP 20
Overvoltage category	I
Pollution degree	2
Input voltage and current	DC 24 V, 6.67 A, 160 W
Output voltage and current per heating channel	DC max. 24 V, max. 2 A

continued...

Table 1: (continued)

Operating and Storage Conditions	
Operating site	Indoor use only
Operating temperature	18–30 °C/64–86 °F (at least 5 °C/9 °F less than set temperature)
Operating humidity	max. 80 % relative humidity (RH)
Operating altitude	max. 2000 m (atmospheric pressure 800–1060 hPa/11.6–15.4 psi)
Storage conditions	-5–50 °C/23–122 °F Humidity <60 % relative humidity (RH)
Outer Dimensions and Characteristics of the Components	
Temperature Controller	90 mm × 170 mm × 230 mm Weight: 1.75 kg/3.86 lbs
Heated Lid of Incubation Chamber 4 Slides	19 mm × 85.5 mm × 127.5 mm (134.5 mm with cover ridge) Length of cable: 1.8 m total, 1.5 m to converter box Connector to Gas Incubation: Push-in
Heated Plate of Incubation Chamber 4 Slides	12 mm × 85.5 mm × 127.5 mm Observation area: 22 mm × 49 mm per μ -Slide Length of cable: 1.8 m total, 1.5 m to converter box
Heated Plate assembled with Heated Lid	Height: 25.5 mm Weight: 330 g/0.46 lbs
USB cable	Length: 1.8 m
Power supply cable	Length: 2.0 m (power supply to wall) Length: 1.2 m (power supply to device)
Temperature Control Range	
Heated Lid	5 degree above ambient temperature (min. 18 °C) to 50 °C Accuracy: ± 0.2 °C (at sensor location) Uniformity: ± 5 °C (entire heated glass)
Heated Plate for 4 μ -Slides	5 degree above ambient temperature (min. 18 °C) to 46 °C Accuracy: ± 0.2 °C (at sensor location) Uniformity: ± 0.5 °C (entire heated plate)
Sample Temperature	
Temperature stability	± 0.2 °C
Recommended temperatures before adjustment	See Section 5.4

continued...

Table 1: (continued)

USB Interface	
Connector type at controller	USB 2.0 Connector Type B
Recommended USB cable	Tripp Lite UR022-006 (shielded)
USB driver for PC	FTDI VCP driver
Optical Properties Glass Lid	
Glass	Selected HQ Floatglass
Thickness of the glass plate	1.1 mm
Refractive index glass	$n_D = 1.520$ (588 nm)
Thickness of ITO coating	100 nm
Thickness of passivation layer	20–25 nm
Refractive index ITO with passivation layer	1.95
Microscope Requirements	
Working distance condenser	≥ 26 mm
Stage holder	Holder for standard multiwell plates

1.5 Disclaimer

- ibidi shall not be held liable, either directly or indirectly, for any damage incurred as a result of product use.
- The contents of this manual are subject to change without notice for product improvement.
- This manual is considered complete and accurate at publication.
- This manual does not guarantee the validity of any patent rights or other rights.
- If an ibidi software program doesn't function properly, this may be caused by a conflict with another program operating on the computer. In this case, take corrective action by uninstalling the conflicting product(s).
- ibidi is a registered trademark of ibidi GmbH in Germany and other countries.

1.6 Safety Considerations



WARNING

- Only operate the ibidi Heating System 4 Slides – Silver Line with the supplied components.
- Only use the cables and plugs delivered with the system. The power plug of the control unit must be inserted in an outlet with a ground (earth) contact.

ibidi Heating System 4 Slides – Silver Line

Instruction Manual

- Do not replace detachable power cables by power cables with inadequate specifications. By violating these instructions, you risk electric shock and fire.
- Only use extension cables that have a protective ground wire.
- Do not operate the ibidi Heating System 4 Slides – Silver Line under conditions that pose a risk of explosion, implosion, or the release of gases.
- Do not place flammable solids, liquids, gases, or gas outlets near the system (e.g., matches, ethanol, propane gas, solvents). Do not bring these products in contact with any other component of the system either.
- Do not operate a damaged ibidi Heating System 4 Slides – Silver Line. If the housing seems damaged or something is rattling inside the controller, contact the [ibidi technical support](#) for repair.
- Only operate the Heated Lid and Heated Plate properly installed on a microscope stage.
- Some accessible parts of the Heated Plate and Heated Lid can reach temperatures up to 55°C. Avoid touching the temperature-controlled parts of the system when you have set the ibidi Temperature Controller – Silver Line to high temperatures.



CAUTION

- Ensure that the external power supply is easily accessible. The ibidi Heating System 4 Slides – Silver Line must be installed in a manner such that none of its components hinders access to the external power supply.
- Immediately replace damaged cords, plugs, or cables to avoid risk of personal injury or damage to the instrument.
- Only ibidi technical staff and technical staff instructed by ibidi are permitted to open and service the ibidi Heating System 4 Slides – Silver Line.
- The external power supply should not be brought into contact with moisture. If the housing is damaged, the external power supply should not be used.
- Avoid strong magnetic fields and sources of high frequency. The ibidi Heating System 4 Slides – Silver Line might not function properly when located near a strong magnetic field or high frequency source.
- Avoid vibrations from vacuum pumps, centrifuges, electric motors, processing equipment, and machine tools.
- Avoid dust and corrosive gas. Do not install the ibidi Heating System 4 Slides – Silver Line where it could be exposed to high levels of dust or to outside air or ventilation outlets.
- Install the ibidi Heating System 4 Slides – Silver Line in a location that enables easy access for maintenance.
- Do not place heavy objects on the instrument.
- Install the ibidi Temperature Controller – Silver Line in a horizontal and stable position, which includes a table, bench or desk upon which the instrument is installed.

- The heated glass plates of the incubation chamber can break on mechanical impact. If so, the glass shards can lead to injuries if handled.
- Be aware that when switched on, a 10 V DC voltage is applied to the underside of the glass on the Heated Lid. Do not touch the underside or put it in contact with anything conductive. This could cause a short circuit that may damage the ibidi Temperature Controller – Silver Line and/or the Heated Devices (e.g., Heated Plate, Heated Lid of Incubation Chambers).

1.7 Limited Warranty

Products manufactured by ibidi, unless otherwise specified, are warranted for a period of one year from the date of shipment to be free of defects in materials and workmanship. If any defects in the product are found during this warranty period, ibidi will repair or replace the defective part(s) or product free of charge.

This warranty does not apply to defects resulting from the following:

1. Improper or inadequate installation.
2. Improper or inadequate operation, maintenance, adjustment, or calibration.
3. Unauthorized modification or misuse.
4. Use of unauthorized tubing or fluidic connectors.
5. Use of consumables, disposables, and parts not supplied by an authorized ibidi distributor.
6. Corrosion due to the use of improper solvents, samples, or due to surrounding gases.
7. Accidents beyond ibidi's control, including natural disasters.

This warranty does not cover consumables, such as cell culture chambers and dishes, tubes, fluidic connectors, reagents, etc.

The warranty for all parts supplied and repairs provided under this warranty expires on the warranty expiration date of the original product.

1.8 Transporting the ibidi Heating System 4 Slides

The weight of the ibidi Temperature Controller – Silver Line is approx. 1.75 kg/3.86 lbs. Moving the ibidi Temperature Controller – Silver Line during operation can pose a risk of personal injury or damage to the instrument.

For transport, switch off the ibidi Temperature Controller – Silver Line and then disconnect the heated components from the controller. Carry the devices carefully and avoid mechanical shocks.



WARNING – Hot surface (max. 55°C)! Do not touch Heated Lid and Heated Plate when hot. Always disconnect the instrument from the power supply before transport and leave the instrument to cool down for approx. 5 minutes.

1.9 Repairing the ibidi Heating System 4 Slides

For inquiries concerning repair service contact ibidi GmbH technical support (techsupport@ibidi.com) and provide the model name and serial number of your system.



CAUTION – Do not try to repair the ibidi Heating System 4 Slides – Silver Line by yourself. Disassembly of the ibidi Heating System 4 Slides – Silver Line is not allowed. Disassembly poses a risk of personal injury or damage to the devices. Contact ibidi technical support if there is a need to disassemble a device.

1.10 Waste Disposal – WEEE/RoHS Compliance Statement

The European Union (EU) has enacted two directives, the first on product recycling (Waste Electrical and Electronic Equipment, WEEE) and the second on limiting the use of certain substances (Restriction on the use of Hazardous Substances, RoHS).

1.10.1 EU Directive WEEE

The ibidi Heating System 4 Slides – Silver Line must be disposed of in compliance with the WEEE Directive 2012/19/EC.



This symbol on the product is in accordance with the European Union's Waste Electrical and Electronic Equipment (WEEE) Directive. The symbol indicates that this product must be recycled/disposed of separately from other household waste. It is the end user's responsibility to dispose of this product by taking it to a designated WEEE collection facility for the proper collection and recycling of the waste equipment. The separate collection and recycling of waste equipment will help to conserve natural resources and protect human health and the environment. For more information about recycling, please contact your local environmental office, an electrical/electronic waste disposal company or distributor where you purchased the product.

1.10.2 EU Directive RoHS

RoHS conformity is declared in the EU-conformity in Section [1.11](#).

1.11 Regulatory Statement

EG-Konformitätserklärung EC Declaration of Conformity

Wir / We

ibidi GmbH
Lochhamer Schlag 11
D-82166 Gräfelfing

erklären hiermit die Übereinstimmung des genannten Produktes mit der Richtlinie 2014/35/EU - Niederspannungsrichtlinie und mit der Richtlinie 2014/30/EU über die Elektromagnetische Verträglichkeit.
Bei Änderungen am Produkt, die nicht von uns autorisiert wurden, verliert diese Erklärung ihre Gültigkeit.

We declare the compliance of the product with the requirements of the Directive 2014/35/EU - Low Voltage Directive and with the Directive 2014/30/EU about the Electromagnetic Compatibility.
Any modification to the product, not authorized by us, will invalidate this declaration.

Laborgerät / laboratory equipment:

ibidi Temperature Controller ibiTC3-XXX with ibidi accessories

Der oben beschriebene Gegenstand erfüllt die Vorschriften der Richtlinie 2011/65/EU vom 08. Juni 2011 zur Beschränkung der Verwendung bestimmter gefährlicher Stoffe in Elektro- und Elektronikgeräten.

The object of the declaration described above is in conformity with Directive 2011/65/EU of 8 June 2011 on the restriction of the use of certain hazardous substances in electrical and electronic equipment.

Das Produkt entspricht den unten aufgeführten Normen:
The product meets the requirements of the following standards:

DIN EN 61010-1:2020

Sicherheitsbestimmungen für elektrische Mess-, Steuer-, Regel- und Laborgeräte - Teil 1: Allgemeine Anforderungen Safety requirements for electrical equipment for measurement, control and laboratory use - Part 1: General requirements

DIN EN 61326-1:2013

Elektrische Mess-, Steuer-, Regel und Laborgeräte. EMV-Anforderungen. Allgemeine Anforderungen
Electrical equipment for measurement, control and laboratory use. EMC requirements. General requirements

Das Produkt ist gekennzeichnet mit/ The product is marked with



Gräfelfing, den 29.07.2021
Gräfelfing, 2021-07-29

Ort/Datum
Place/date

Dr. Valentin Kahl
Geschäftsführer

Name, Funktion
Name, Function

Unterschrift
Signature

Diese Erklärung bescheinigt die Übereinstimmung mit den genannten Richtlinien, ist jedoch keine Zusicherung von Eigenschaften. Die Sicherheitshinweise der Produktdokumentation sind zu beachten.

This declaration certifies the conformity to the specified directives but not includes any warranted quality of the instrument. The safety documentation of the product shall be considered in detail.



2 Intended Use

The ibidi Heating System 4 Slides – Silver Line is a stage top incubator for live cell imaging that fits onto inverted microscope stages with a mounting frame for multiwell plates. The ibidi Heating System 4 Slides, consisting of an Incubation Chamber with Heated Plate and Heated Lid and a Temperature Controller, provides a platform for keeping ibidi μ -Slides at a constant temperature during an experiment on a microscope.

For full control of the incubation environment, the ibidi Heating System 4 Slides can be combined with the ibidi Gas Incubation System to regulate the CO_2 and O_2 concentrations as well as the humidity.

The ibidi Heating System 4 Slides is for research use only! It is not intended for use in diagnostic procedures.

3 Principle

Physiological Conditions in Live Cell Imaging

Cells react sensitively to changes in their environment. Factors such as temperature, humidity, and CO_2/O_2 levels significantly influence the outcome of cell culture assays. In order to achieve biologically relevant and reproducible results, it is crucial to maintain optimal conditions on the microscope stage during live cell imaging experiments.

To enable high-quality live cell imaging under physiological conditions (Figure 1), the following parameters need to be considered:

Environment:

- Temperature
- Carbon dioxide (CO_2) levels and pH of the medium
- Humidity and evaporation
- Oxygen (O_2) levels

Optical Aspects:

- Condensation
- Imaging method and photon dose

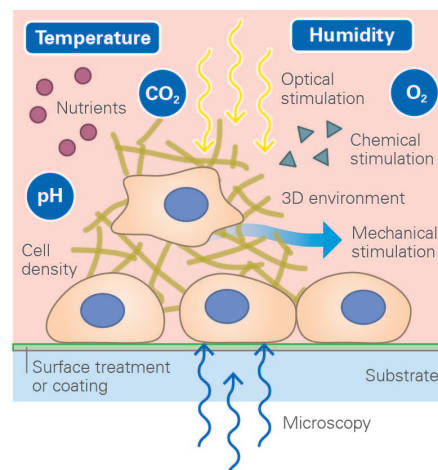

Figure 1: Live cell imaging conditions.

The Heating System combined with the Gas Incubation System supplies complete incubator conditions for your live cell imaging directly on the microscope stage.

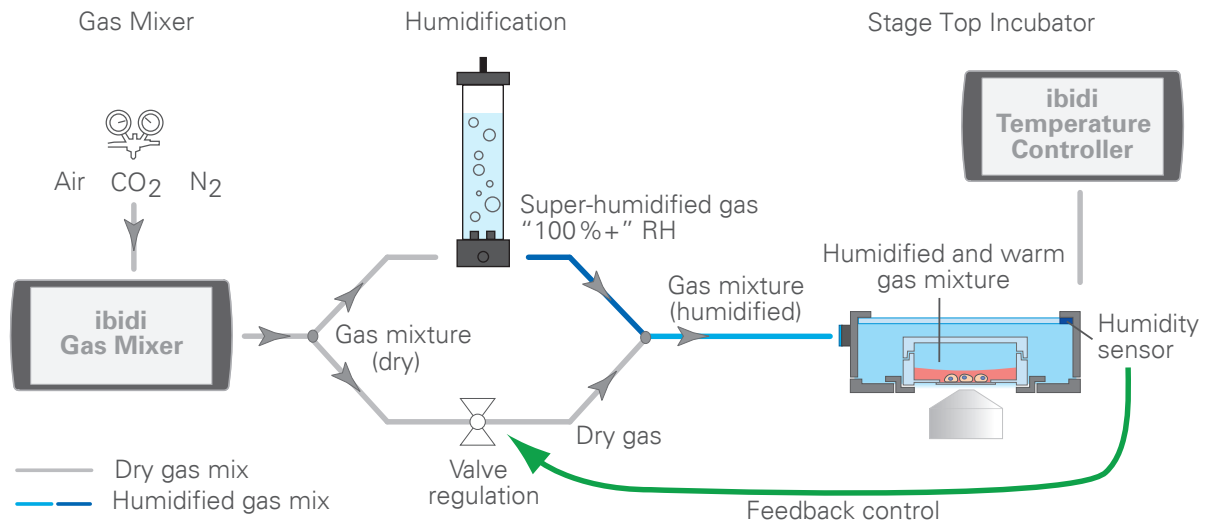

Figure 2: Schematic view of the ibidi Stage Top Incubation System, combining the Heating System with the Gas Incubation System. RH: relative humidity.

The Gas Incubation System provides a controlled atmosphere of gas (CO₂ or CO₂/O₂) as well as a defined humidity in the emitted gas stream that is flushed continuously through the Incubation Chamber (Figure 11). Oxygen can be reduced during the experiment, enabling the user to perform hypoxia experiments (CO₂/O₂ version only).

Humidity in ambient air can lead to condensation on all surfaces, especially on the lids of cell culture vessels. If these surfaces are within the optical pathway, small water droplets will cause light scattering. This diminishes the optical quality of transmitted light microscopy (i.e., phase contrast). To ensure the highest image quality, condensation on any surface should be prevented during live cell imaging experiments.

The independently controlled Heated Lid of the ibidi Heating System prevents condensation during live cell imaging (Figure 3). By heating the lid to a temperature higher than the plate, a vertical temperature gradient is created. This gradient and active humidity control prevent the formation of condensates on the lid of the cell culture vessel.

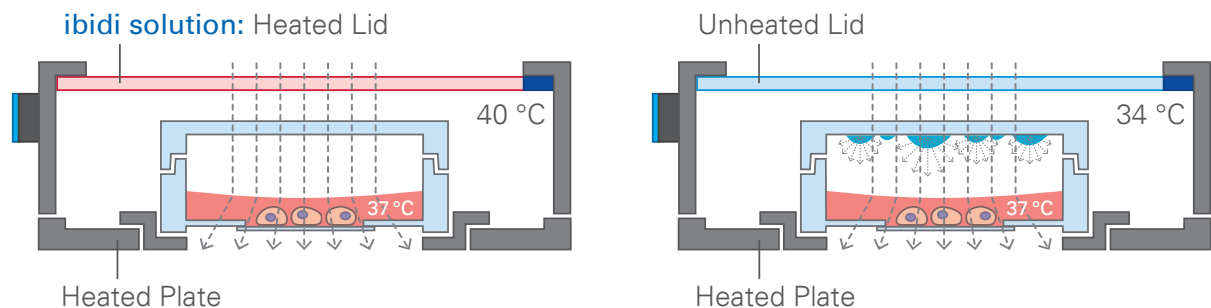

Figure 3: The Heating System prevents condensation on the cell culture vessel lid, as well as on the Heated Lid itself.



4 Equipment

This Section provides a brief overview over all parts of the ibidi Heating System 4 Slides – Silver Line including a description of the characteristics.

4.1 Components of the ibidi Heating System 4 Slides



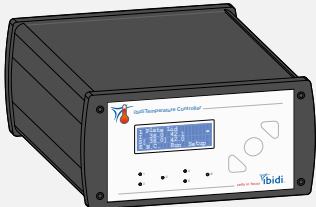
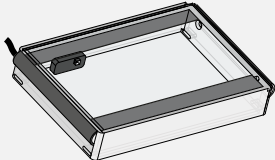
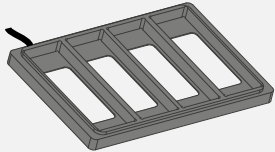

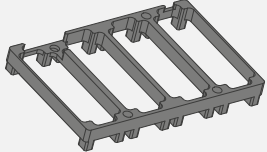
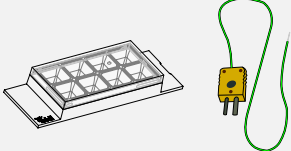
The components of the ibidi Heating System 4 Slides are listed in table 2 below.

Table 2: Overview of the components of the ibidi Heating System 4 Slides

Component Name	Drawing
ibidi Temperature Controller – Silver Line	
Heated Lid with electrical cable to the converter box	
Heated Plate for 4 μ-Slides with electrical cable to the converter box	
Converter box connected to the cables of the Heated Plate and Heated Lid, with multipole connector to the ibidi Temperature Controller – Silver Line	
Magnetic Holder to fix the slides on the Heated Plate	
Temperature Adjustment Set: 1 temperature sensor 1 perforated ibidi μ-Slide 8 Well high	

continued...

Table 2: (continued)

Component Name	Drawing
USB cable to connect the ibidi Temperature Controller – Silver Line with a computer	
Country-specific power cord to connect the external power supply to the wall socket	
External power supply for the ibidi Temperature Controller – Silver Line	
Cable clip for optional use	

4.2 Stage Top Incubator Overview

The parts of the ibidi Heating System 4 Slides are set up as a stage top incubator as shown in Figure 4. The ibidi Heating System 4 Slides can be combined with the ibidi Gas Incubation System – Silver Line in order to provide CO₂ and (optional) O₂ control and a defined humidified atmosphere. Detailed information on the ibidi Gas Incubation System – Silver Line is given in the [Gas Incubation System instructions](#).

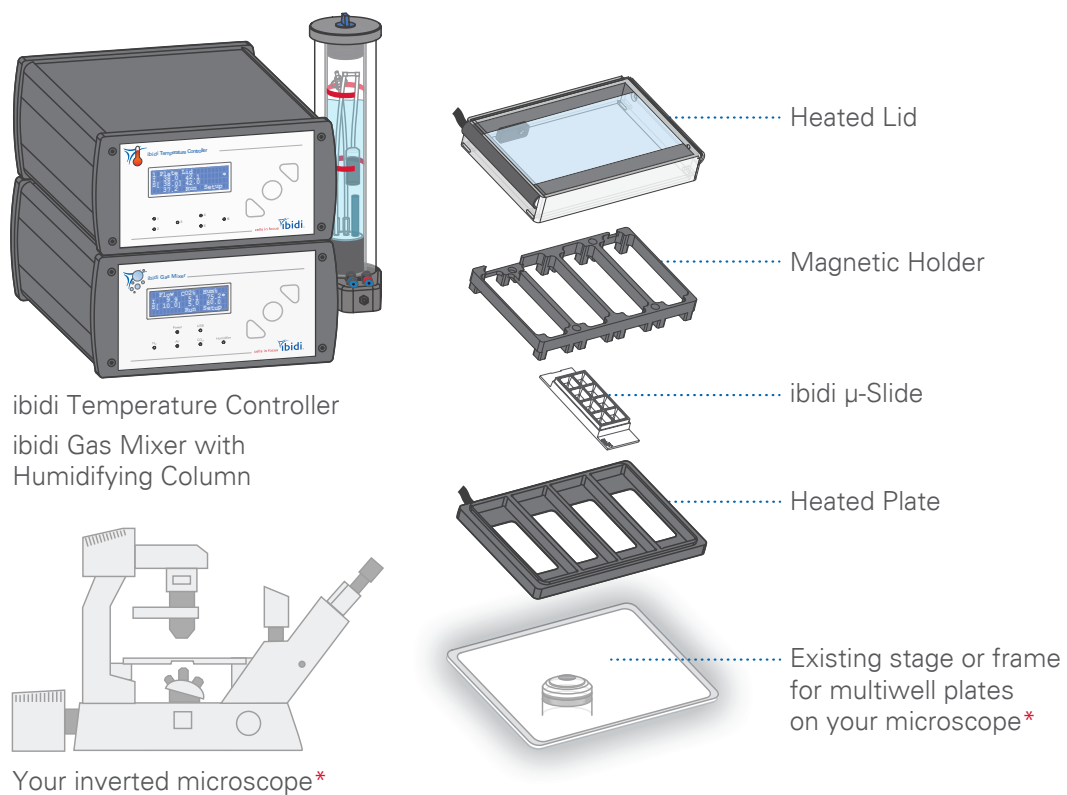

* Not part of the ibidi Stage Top Incubator.
Please contact us for information on suitable microscopes.

Figure 4: Overview of the parts of the ibidi Heating System 4 Slides, combined with the ibidi Gas Incubation System for a full stage top incubator.

ibidi Heating System 4 Slides – Silver Line

Instruction Manual

The Incubation Chamber 4 Slides fits on an inverted microscope stage equipped with a mounting frame for multiwell plates. For parallelization of experiments, the Heated Plate for 4 μ -Slides provides a platform to observe 4 slides in parallel.

Optionally, the Objective Heater Universal – Silver Line can be connected to the Temperature Controller to keep the objective warm, thereby avoiding cooling of the sample by heat transfer from the sample to the objective while imaging. Detailed information on the Objective Heater Universal is given in the [Objective Heater Universal – Silver Line instructions](#).

4.3 ibidi Temperature Controller – Silver Line

The ibidi Temperature Controller – Silver Line is designed to precisely operate the different ibidi Silver Line heating devices, including the Incubation Chamber 4 Slides – Silver Line. In total, 6 channels are available, each channel accommodating one heated component (e.g., the Heated Lid and Heated Plate of the Incubation Chamber 4 Slides). In addition, an external Temperature Sensor can be connected.

The front panel enables access to the Temperature Controller's settings (Figure 5). The front panel display shows the values of set ("S" = set) and actually measured ("I" = is) temperatures. The temperature set values and other settings can be adjusted via the control buttons (Section 5.3). If you wish to control the Temperature Controller via PC, use the IncuControl software (Section 6). The LEDs of the front panel indicate the status of the channels (Table 3).

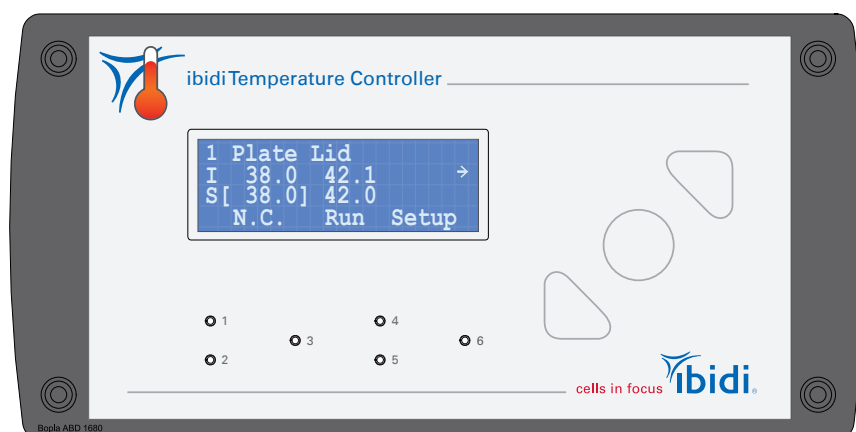

Figure 5: Front view of the ibidi Temperature Controller – Silver Line.

Table 3: LED status in front panel

LED Status	Significance
LED off	Channel inactive
LED on	Channel active
LED fast blinking	Channel error Please contact ibidi at techsupport@ibidi.com .

All electrical connectors are located on the back of the Temperature Controller (Figure 6). For connecting the heating devices, two port sizes are available. The larger ports 1/2 and 4/5, which each accommodate two output channels, and the smaller ports for the output channels 3 and 6. Please find which heating units can be connected to which port in Table 6. Refer to Section 5.6.1 for setting up the ibidi Heating System 4 Slides.

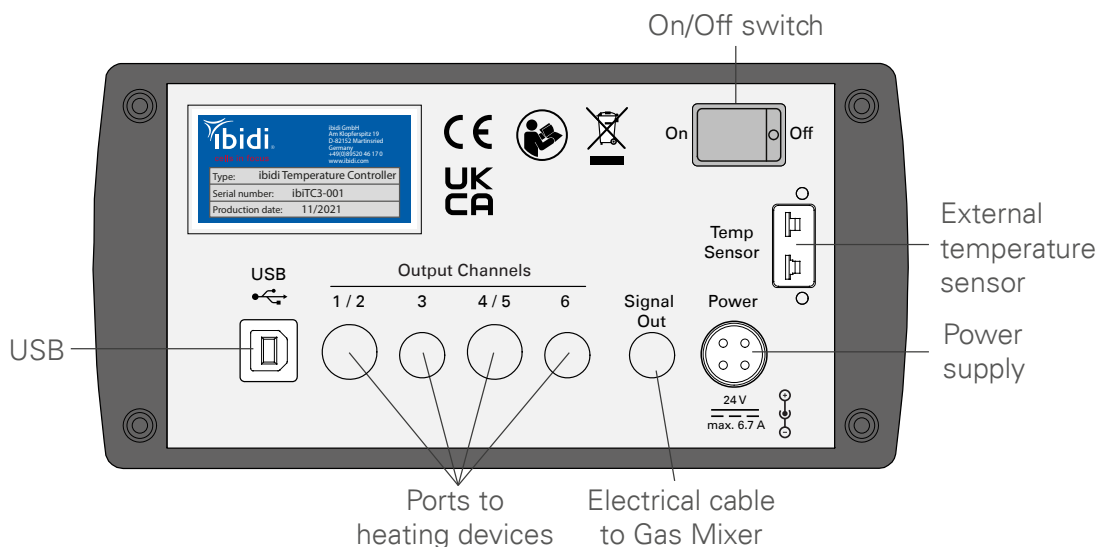

Figure 6: Rear view of the ibidi Temperature Controller – Silver Line.

4.4 Heated Plate and Magnetic Holder

The Heated Plate provides the base for the ibidi Heating System 4 Slides. It fits into any microscope stage with a mounting frame for multiwell plates. The Heated Plate offers four cavities to mount μ -Slides for parallel observation on the microscope (Figure 7). To prevent shifting of the samples, put the magnetic holder on top of the μ -Slides (Figure 8).

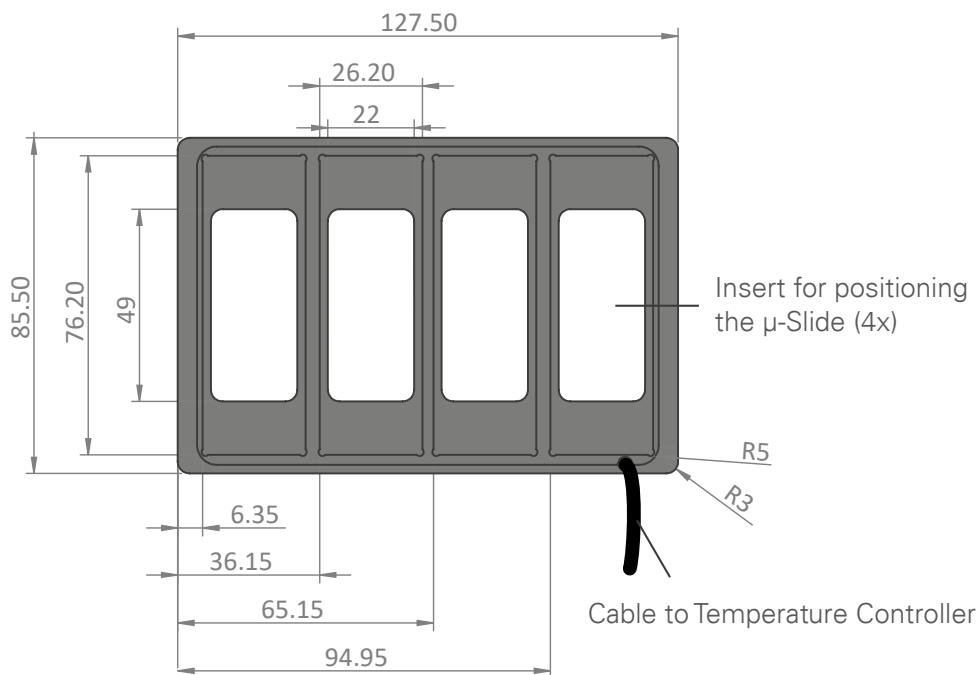

Figure 7: Heated Plate for 4 μ -Slides, top view.

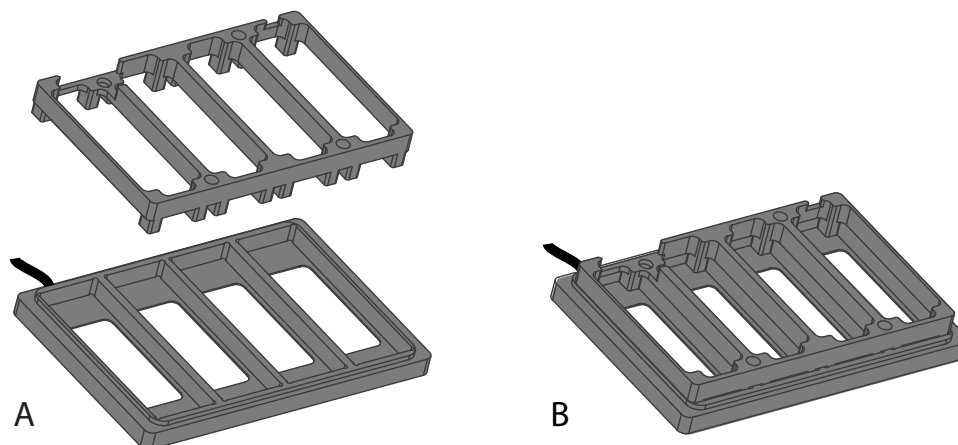

Figure 8: Heated Plate for 4 μ -Slides (lower part) and magnetic holder (upper part) (A) and assembled (B).

4.5 Heated Lid

The Heated Lid provides excellent optical quality, and also allows for the use of all standard microscopy techniques, including differential interference contrast (DIC). Due to the height of the lid, use condensers with a working distance of ≥ 26 mm.

The upper glass part of the Heated Lid is heated. The electrical cable is connected to the ibidi Temperature Controller – Silver Line (Figure 9). The Heated Lid fits exactly and securely onto the Heated Plate.

For gas incubation, the Heated Lid is equipped with inlets for the gas flow and the humidity sensor. Detailed information on the Gas Incubation System is given in the instruction manual of [ibidi Gas Incubation System – Silver Line](#).

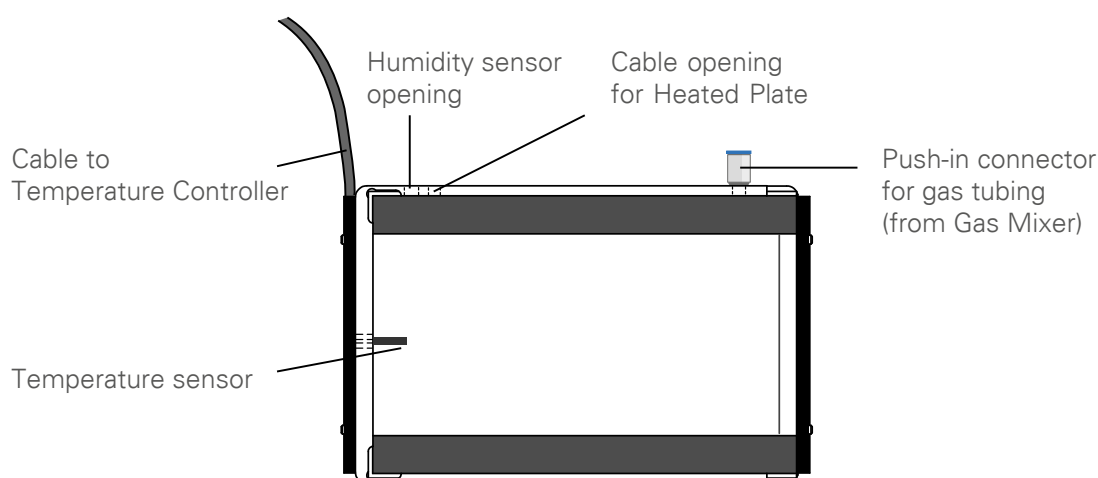

Figure 9: Heated Lid.

4.6 Cable Clip for Optional Use



CAUTION – ibidi GmbH does not accept any liability for damages resulting from the use of the cable clip on your microscope. Please check with your microscope provider and/or your institution's technical support if using the cable clip on the microscope stage is allowed.

The cable clip can optionally be used on your microscope stage to reduce the strain from any cables and gas tubing on the Incubation Chamber to a minimum. Please check with your microscope provider and/or your institution's technical support if modifications to the microscope stage are allowed.

The cable clip comes with a self-adhesive tape on the underside that can be applied once to a smooth surface. To use the clip, define the optimal position of the clip on your stage, before removing the protective foil from the self-adhesive tape and mounting the clip to the stage by slight pressure. It takes about one hour until full adhesion strength of the tape has been reached. Open the clamp (Figure 10) and introduce all cables and tubing leading from the Incubation Chamber to the controller(s).

The clip's adhesive is one-time-use. When you want to permanently remove the cable clip, you can easily do so by soaking the adhesive tape with isopropanol (70%) for about 20–30 s, followed by careful removal of the clip via circular movements. Dry away the remaining isopropanol with a lint-free tissue.

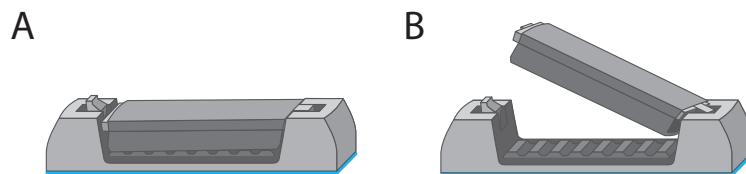

Figure 10: Cable clip for optional use on microscope stage. (A) closed, (B) open.



CAUTION – Please consult the manufacturer of the microscope stage regarding compatibility with isopropanol beforehand. The use of isopropanol or other types of organic solvents may remove the instrument's paint.

4.7 Optional Equipment

4.7.1 Objective Heater Universal – Silver Line

The Objective Heater Universal – Silver Line (product number 12170) is not included in the Heating System Slide/Dish – Silver Line, but can be purchased separately. It can be used with the Heating System Slide/Dish – Silver Line (product numbers 12110, 12720, 12722, 12111) and the Heating System 4 Slides – Silver Line (product numbers 12130, 12131).



NOTE – The Objective Heater is only compatible with the ibidi Temperature Controller – Silver Line.



CAUTION – Not all objectives/lenses tolerate heat! Please check with the manufacturer of your objective if it can be heated.

The Objective Heater Universal – Silver Line is a heating device for microscope objectives used for live cell imaging and is only compatible with the ibidi Temperature Controller – Silver Line. Heating the microscope objective with the Objective Heater prevents strong temperature gradients between the sample and the objective. This is especially important for high magnification objectives that are in close contact with the sample (e.g., water or oil immersion objectives). Using the Objective Heater improves the ability to keep the sample temperature at a defined and stable temperature (Figure 11). The Objective Heater includes a flexible heating element that can be easily wrapped and secured by a Velcro® fastener around the microscope objectives. This enables efficient heating by a large contact area between the microscope objective and the Objective Heater.

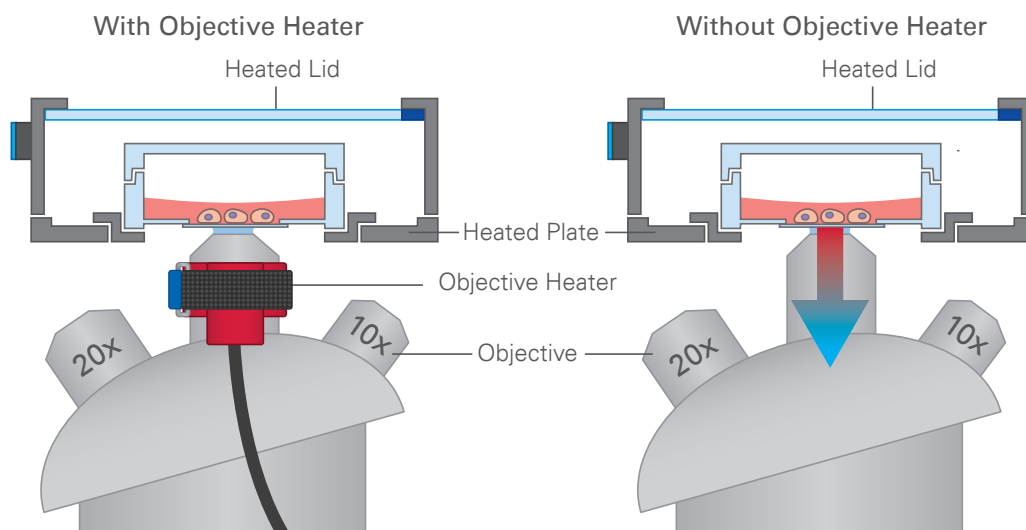
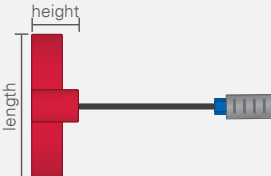

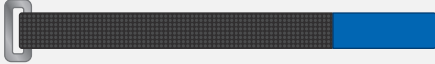

Figure 11: Schematic illustration of a live cell imaging setup with an ibidi Stage Top Incubator and the Objective Heater for optimal temperature stability of the sample.

The components of the Objective Heater Universal – Silver Line are listed in table 4 below:

Table 4: Overview of the components of the Objective Heater Universal – Silver Line

Component Name	Drawing
Flexible heating unit (red) with cable and break-away connector (female)	
Cable for connecting the Objective Heater to the Temperature Controller, with break-away connector (male), converter box and plug	
Velcro® fastener for holding the Objective Heater on the objective	

Only operate the Objective Heater in the range of the specifications given in table 5 below and as indicated in Section 5.6:

Table 5: Specifications of the Objective Heater Universal – Silver Line

Electrical Specifications	
Overvoltage category	III
Input line voltage	DC 24 V, 2 A, 48 W
Operating Conditions	
Operating site	Indoor use only
Operating temperature	18–30 °C/64–86 °F (min 5 °C/9 °F less than set temperature)
Humidity	80% relative humidity (RH) up to 31 °C/87 °F 30% relative humidity (RH) up to 40 °C/104 °F
Operating altitude	max. 2000 m (atmospheric pressure 800–1060 hPa/11.6–15.4 psi)
Storage conditions	-5–50 °C/23–122 °F, humidity <60% relative humidity (RH)
Outer Dimensions and Characteristics	
Length of flexible heating unit	12 cm
Height of flexible heating unit	2 cm
Length of cable	232.5 cm
Weight of heating unit including cable	110 g

continued...

Table 5: (continued)

Fit With Microscope Objectives

Diameter of Objectives	~ 2.5–4.5 cm
------------------------	--------------

Compatibility With Temperature Controllers and Temperature Control Range

Compatibility	ibidi Temperature Controller – Silver Line
Temperature control range	Ambient temperature (min. 18 °C/64 °F) to 45 °C/113 °F
Recommended temperature settings	See Section 5.6.2



WARNING – Only operate the Objective Heater with the supplied components and the Temperature Controller.

Some accessible parts of the Objective Heater can reach temperatures up to 65 °C. Avoid touching the temperature-controlled parts of the system when you have set the Temperature Controller to high temperatures.

Do not operate a damaged Objective Heater. If the Objective Heater seems to be damaged, contact techsupport@ibidi.com.

Only operate the Objective Heater properly installed to a microscope objective.



CAUTION – Not all objectives/lenses tolerate heat! Please check with the manufacturer of your objective if it can be heated.

Do not try to repair or disassemble the Objective Heater yourself. Disassembly poses a risk of personal injury or damage to the devices. Contact ibidi technical support if there is a need to disassemble a device.

Do not place heavy objects on the Objective Heater and do not fold the Objective Heater.

5 Operation

Before starting an experiment, check that the ibidi Heating System 4 Slides fits on your microscope stage, and that your cell culture vessels are compatible with the Holder. Connect all parts (Section 5.6.1) and perform a temperature adjustment as explained in Section 5.4.



NOTE – The ibidi Temperature Controller – Silver Line only measures the temperature from the sensors in the Heated Lid and Heated Plate. The temperature in the sample must be adjusted for your specific setup. Follow the instructions in Section 5.4.

5.1 Installation and Connection of the Components

The components of the ibidi Heating System 4 Slides are connected as shown in Figure 12.

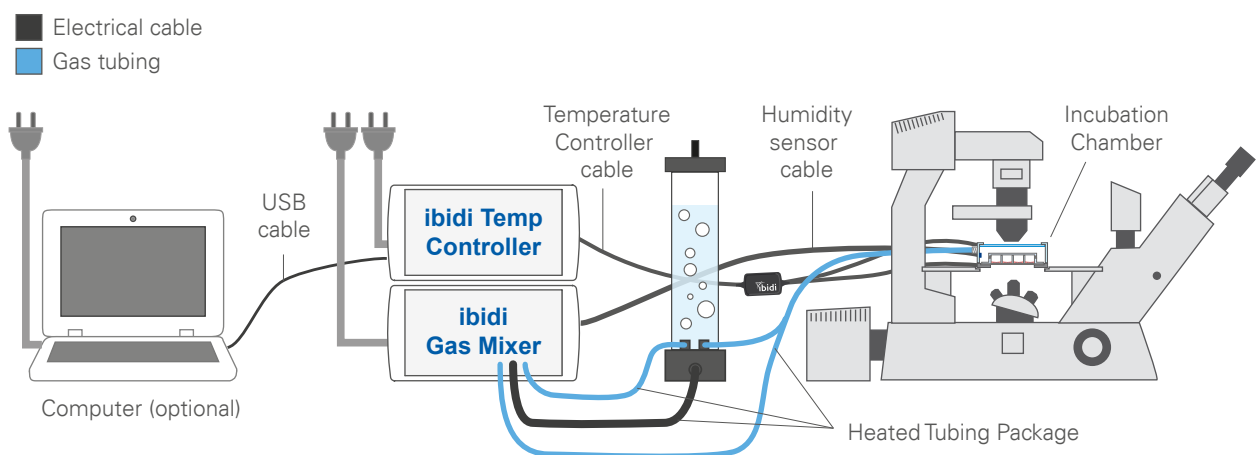

Figure 12: Installation of the components of the ibidi Heating System 4 Slides.

1. Confirm that the power switch of the Temperature Controller is off.
2. Place the ibidi Temperature Controller – Silver Line next to the microscope and connect the power supply.
3. Insert the Heated Plate into the opening of the mounting frame on the microscope stage.
4. Insert four μ -Slides into the four inserts of the Heated Plate.
5. Place the magnetic holder onto the μ -Slides and the Heated Lid onto the Heated Plate.
6. Plug the electrical cables of the Incubation Chamber into the connectors (1/2 or 4/5) at the back of the Temperature Controller (Section 5.3).
7. Switch on the controller by the dip switch. All connected components are recognized.
8. Set the parameters via the front display and wait for the temperature to equilibrate (Section 5.3). It is recommended to start the system at least 30 minutes before adding cells.

Optional:

Before starting an experiment for the first time, an initial temperature adjustment must be performed (see Section 5.4). To adjust the sample temperature, use the temperature sensor in the Temperature Adjustment Set and plug it into the corresponding connector at the back of the Temperature Controller.

To setup communication with the IncuControl Software, the USB cable must be connected to the Temperature Controller and the computer (Section 6).

5.2 Start Operation of the ibidi Heating System 4 Slides

The ibidi Temperature Controller – Silver Line is switched on with the dip switch at the back. Make sure the display shows “RUN” (see Section 5.3.1). The system immediately starts heating up the connected devices (e.g., Heated Plate, Heated Lid) to set values.



WARNING – Be aware that when the system is switched on, 10 V DC voltage is applied to the ITO coated glass plate of the Heated Lid. Do not touch the underside or contact it with anything conductive! This could cause a short circuit that may destroy the controller and/or the lid.

If you are not sure which temperature is set (e.g., when operating the system the first time), it is recommended to check the settings without your sample.

5.3 Setting Parameters in the Front Display

All control parameters can be manually set on the controller using the buttons on the front display (Figure 13).

The cursor position is indicated with square brackets (“[]”). You can move the cursor using the “left” and “right” buttons. If you want to select a parameter or a function, press the round button, and the square brackets will change to angle brackets (“< >”). Now you can change the value with the “up” and “down” buttons. To confirm the changed value, press the round button once more.

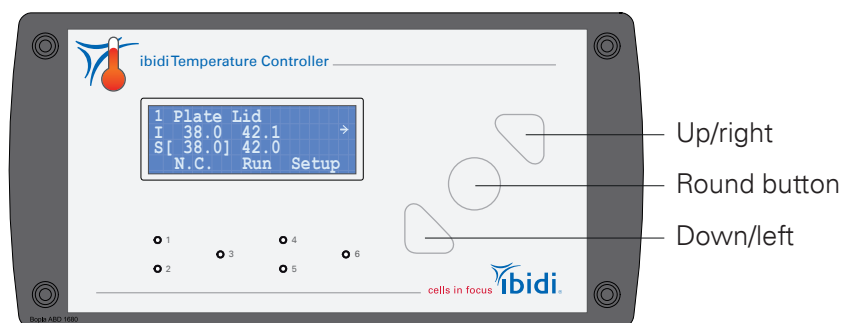

Figure 13: ibidi Temperature Controller – Silver Line front display and set buttons.

The display shows each connected heating component (e.g., Heated Lid, Heated Plate, Objective Heater (optional)). A display number (1–4) is indicated in the upper left corner of each display (Figure 14). Navigate between the displays using the “left” and “right” buttons. Per display, one, two or three heating components are shown (Table 6).

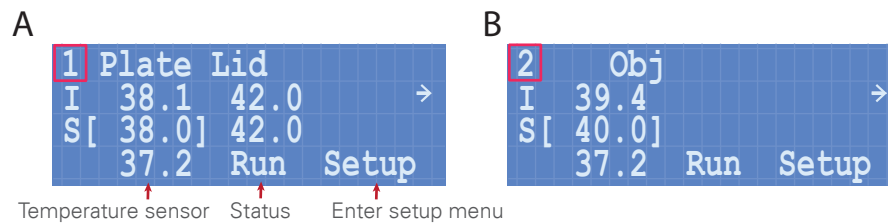

Figure 14: Display of the incubation parameters (is “I” and set “S” values) (A) Display No. 1, (B) Display No. 2.

The first three lines of the display show the respective set (“S” = set) and actual (“I” = is) temperature values of the corresponding components. If a heating system component is not connected properly, “N.C.” will be shown in the “I”-value line.

The bottom line shows the readout temperature of the temperature sensor (if connected), as well as the status of the device (“Run” or “Stop”). On the bottom right, you can switch to the settings menu via “Setup”.

The connector ports (output channels) on the back of the ibidi Temperature Controller – Silver Line (labeled 1/2, 3, 4/5, and 6) are designed to work with specific heated components. Refer to Table 6 to ensure the components, Plate, Lid, Glass, or Obj (for Objective Heater), are connected to the system and shown on the display (display no. 1 – 4) correctly.

Table 6: Output channel assignment and display of the respective heated components

Channel No.	Compatible Heated Components	Display No.	Column Title(s)
1/2	Incubation Chamber Slide/Dish – Silver Line	1	Plate Lid
	Incubation Chamber 4 Slides – Silver Line	1	Plate Lid
3	Objective Heater – Silver Line	2	Obj
1/2 and 3	Incubation Chamber Multiwell Plate	1+2	Plate Lid Glass
4/5	Incubation Chamber 4 Slides	3	Plate Lid
6	Objective Heater – Silver Line	4	Obj
4/5 and 6	Incubation Chamber Multiwell Plate	3+4	Plate Lid Glass

5.3.1 Run/Stop Mode

Set the whole system to run or stop mode by changing the setting in the bottom line of the display to “Run” (= system is running) or “Stop” (= system is not running), respectively.

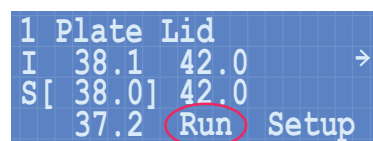

Figure 15: Main display indicating “Run”.

5.3.2 Setup Menu

The Setup menu offers the possibility to change the settings of the individual channels and the display. For standard operation, no changes need to be made. Enter the setup menu by navigating to the “Setup” entry and pressing the round button. Within the setup menu, navigate between the following dialog windows:

Mode: Each channel of the ibidi Temperature Controller – Silver Line can be set to an “On” or “Off” state. For standard operation, all channels must be turned on.

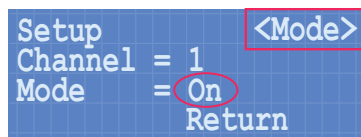

Figure 16: Mode dialog.

1. Press the round button once more to move the cursor to the channel number.
2. Select the respective channel and confirm with the round button.
3. Select “On” or “Off” and confirm with the round button.
4. To move on, navigate to “Return” and press the round button.

Alarms: In this dialog, setting the alarm limits for deviating control parameters is possible. Move from the mode menu to the alarm menu by pressing the “up/right” button.

The maximum and minimum limits of the alarm can be set for each individual channel. The display will start blinking if a value goes below/above the low/high limits. It will alternate between showing the current value (I) and the words “low” or “high” to alert you. To stop the display blinking, navigate to the blinking channel and press the round button once.

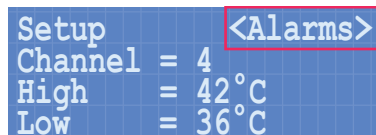

Figure 17: Alarm settings dialog.

Preferences: Set the brightness and contrast of the display in the preferences menu.

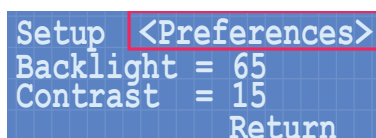

Figure 18: Preferences dialog.

Info: Information about the serial number (SN) and firmware (FW) version is shown in the info dialog.

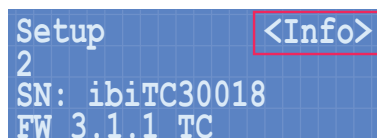

Figure 19: Info display.

5.4 Temperature Adjustment in the Sample

The ibidi Temperature Controller – Silver Line controls the temperature of the actively heated components (Heated Lid and Heated Plate). The temperature in the sample is affected primarily by the temperature of the Heated Plate. Due to heat loss to the surrounding environment, the Heated Plate must usually be set to a temperature slightly above the desired temperature in the sample. The Heated Lid acts primarily to prevent greater heat loss to the environment and to prevent condensation in the chamber during microscopy experiments; it should generally have a temperature several degrees above that of the Heated Plate. To ensure that the sample reaches the correct temperature, ibidi recommends a temperature adjustment step before starting the first experiment. The temperature adjustment should also be done separately for each chamber type used.

When starting the temperature adjustment in the sample in your specific setup, use the recommended temperature settings (e.g., for a 37°C sample temperature):

Table 7: Recommended temperature settings before optimization

Device	Temperature
Heated Lid	42°C
Heated Plate	38°C

To measure and adjust the sample temperature, use the provided Temperature Adjustment Set (temperature sensor and culture vessel with perforated lid). The temperature of the heated components has to be adjusted in small steps. Follow this procedure to adjust the sample temperature:

1. Set all your peripheral experimental parameters, such as room temperature, air conditioning, airflow, illumination, microscope settings, etc.
2. Connect the external temperature sensor (thermocouple type K) to the plug at the back of the ibidi Temperature Controller – Silver Line. The connected external temperature sensor will appear on the display.
3. Fill the provided culture vessel (μ -Slide 8 Well high) with water or medium. Volumes should be the same amount you need for your experiments.
4. Put the loose end of the thermocouple through the hole in the lid of the culture vessel and make sure it dips into the liquid.
5. Place the μ -Slide with the temperature sensor and three further slides into the Heated Plate.

6. Close the Incubation Chamber with the Heated Lid.
7. After 30 minutes, check the temperature of the external sensor on the display or in the Incu-Control software. If the sample temperature is still too low, raise the set values for the Heated Plate and Heated Lid by 0.5–1 °C, each, and wait until the sample temperature is stable again (at least 10–15 min).
8. When the sample temperature has reached the desired value, write down the set values for the Heated Plate and Heated Lid and use those settings for all upcoming experiments with the same sample holder.



NOTE – The temperature of the Heated Lid must be set to at least 1–2 degrees higher than the temperature of the Heated Plate!

The temperature adjustment must be repeated from time to time (at least once a year), especially if one of the following conditions have changed:

- Room temperature
- Air conditioning
- Chamber type or objective lens
- Humidification and gas flow
- Use of an XL-Incubator
- Use of an Objective Heater

5.5 Sample Preparation

Check that the cell cultureware you intend to use fits into Heated Plate of the ibidi Heating System 4 Slides.

Prepare the cells according to your protocol and place the μ -Slides into the Heated Plate mounted on the microscope stage. Close the Heated Lid.



NOTE – Let the temperature of the system equilibrate for a minimum of 30 min before you start your experiments.

5.6 Using ibidi Heating System 4 Slides with the Objective Heater Universal – Silver Line

Before starting an experiment, check that the Objective Heater fits your microscope objectives (see Section 4.7.1).



CAUTION – Not all objectives/lenses tolerate heat! Please check with the manufacturer of your objective if it can be heated.



NOTE – The Temperature Controller controls the temperature of the Objective Heater according to the sensor inside the heating unit of the Objective Heater. As the Objective Heater dissipates heat to the objective and the sample, the temperature of the Objective Heater is typically set higher than the target temperature of the sample. To adjust the temperature within the sample to a specific target temperature, follow the instructions in Section 5.4.

5.6.1 Installation and Connection of the Objective Heater Universal – Silver Line

Objectives come in different sizes and lengths, depending on manufacturer and magnification. Hence, there are two different ways to mount the Objective Heater to a microscope objective (Figure 20).

1. Test if the heating unit significantly overlaps when wrapped around the objective. If there is no overlap, proceed with steps 2A and 3A. If there is an overlap, which is not optimal for homogenous heating, proceed with steps 2B and 3B.

2A. Thread the blue end of the Velcro® fastener through the metal buckle and create a loose loop that can be easily placed over the objective.

3A. Bend the heating unit of the Objective Heater around the objective, the cable directed toward the microscope's revolving nosepiece (turret). Next, place the Velcro® fastener around the heating unit while holding it in place, and secure the Objective Heater in the desired position by closing the Velcro®.

2B. Thread the blue end of the Velcro® fastener and one end of the heating unit carefully through the metal buckle and create a loose loop that can be easily placed over the objective.

3B. Place the Objective Heater around the objective, the cable directed toward the microscope's revolving nosepiece (turret). Fasten the Velcro® fastener and heating unit around the objective so there is enough contact between the heating unit and the objective. Close the Velcro®.

4. Connect the electrical cable of the Objective Heater to port 3 or 6 at the back of the Temperature Controller.

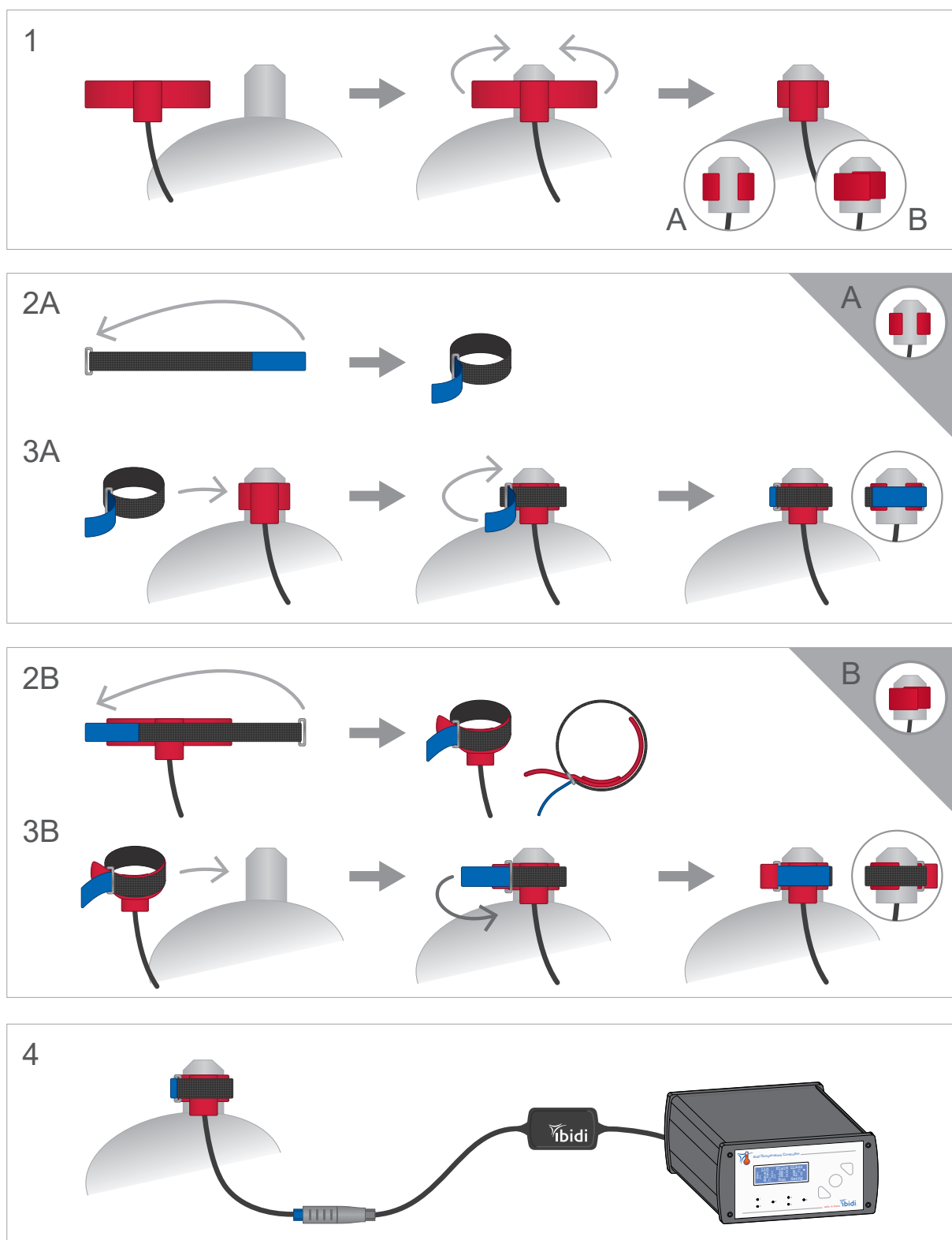

Figure 20: Mounting of the Objective Heater to an objective.

A break-away connector in the cable between the Objective Heater and the Temperature Controller allows for emergency release of the Objective Heater from the Temperature Controller (see Figure 21). If a force above about 14 N acts on the cable of the Objective Heater, the break-away connector releases open to prevent any force from being transferred to the microscope's objective.

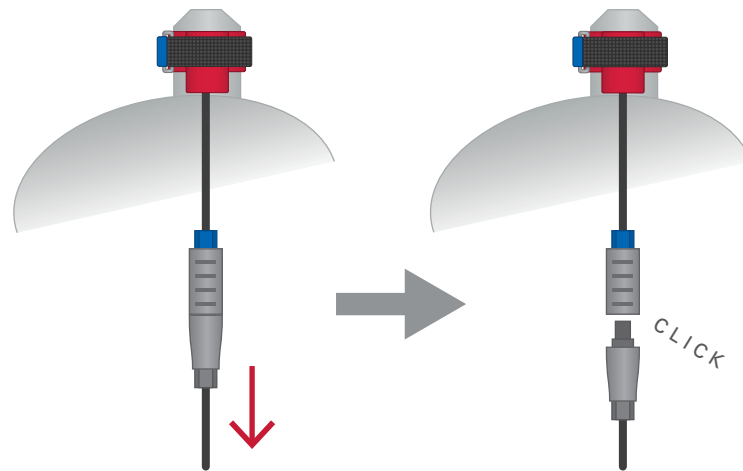

Figure 21: Principle of the emergency release mechanism by a break-away connector in the cable between the Objective Heater and the Temperature Controller.

5.6.2 Temperature Adjustment of the Objective Heater Universal – Silver Line

ibidi recommends a temperature adjustment before starting the first experiment to ensure that the sample reaches the correct temperature. The temperature in the sample is affected primarily by the temperature of the Stage Top Incubator. In addition, the temperature of the microscope objective can contribute to the sample temperature by heat transfer from the sample to the objective and vice versa. The temperature of the Objective Heater is regulated by the Temperature Controller. Please follow the instructions for temperature adjustment of the Objective Heater as described below:

1. Adjust the temperatures of Heated Plate and Heated Lid so that the target temperature for the sample is reached (e.g., 37 °C), while the objective is not yet in contact with the sample (Section 5.4).
2. As soon as the target temperature of the sample is reached, bring the cold objective in contact with the sample. The temperature of the sample will most likely drop (see Figure 22). Wait until the temperature of the sample reaches a stable plateau.
3. To bring the sample temperature back to the target temperature, heat the Objective Heater to an initial temperature between 38 °C and 45 °C. The optimal temperature depends on the diameter and material of your objective. Wait until the temperature is stable again.
4. Adjust the temperature of the Objective Heater, if necessary. We recommend beginning the temperature adjustment with a low temperature and increasing it stepwise by 0.5–1 °C.

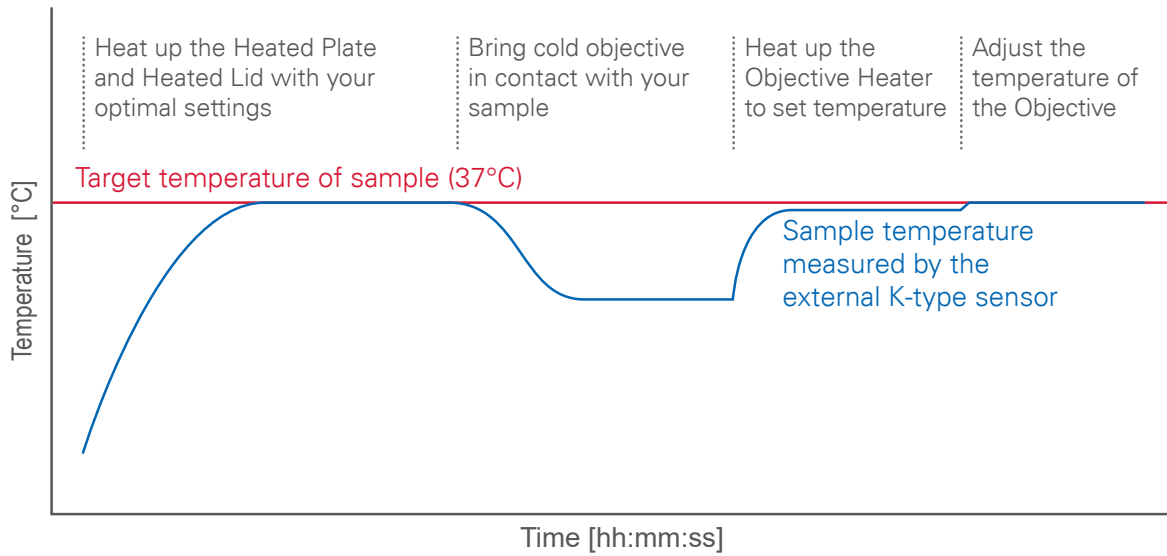

Figure 22: Temperature adjustment procedure to adjust the sample temperature to the target temperature.

6 IncuControl Software

The ibidi Temperature Controller – Silver Line has a USB interface for computer control and data logging. For this purpose, ibidi provides the IncuControl software that can be downloaded from the [ibidi website](https://www.ibidi.com) or directly via [ibidi.com/stagetop](https://www.ibidi.com/stagetop).

For more details, please refer to the [IncuControl instructions](#).

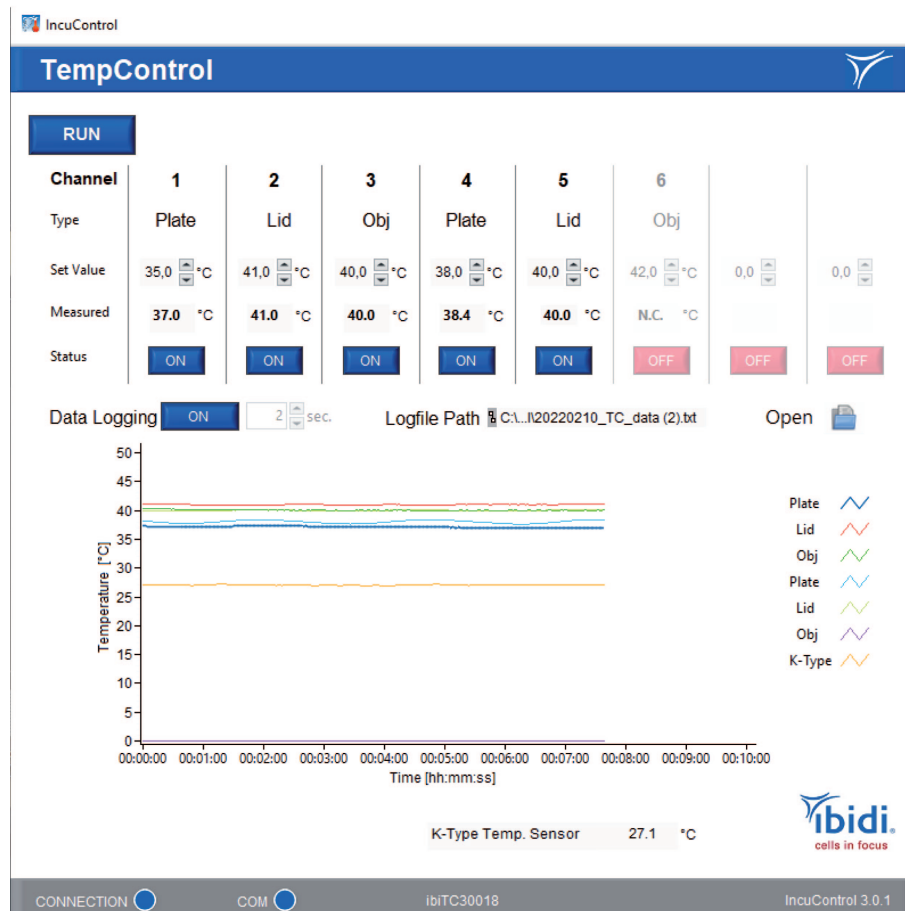

Figure 23: Temperature control window in IncuControl.

Prohibitions on the use of ibidi software:

The following actions are prohibited:

- Copying software for other than backup purposes
- Transferring or licensing of the right to use software to a third party
- Disclosure of confidential information regarding software
- Modification of software

7 Maintenance

7.1 Disinfection and Cleaning

The heated components and the ibidi Temperature Controller – Silver Line do not have to be sterile, because the incubation chamber has no direct contact with the cells and the cell culture medium. If disinfection is necessary for some reason, we recommend using isopropanol (70%) or common lab disinfection solutions based on quaternary ammonium compounds (e.g., Barrycidal® 36 or Pharmacidal™).

All parts of the ibidi Heating System 4 Slides can be cleaned from the outside. We recommend using ultrapure water for cleaning. Fingerprints on the Heated Lid can be removed using isopropanol (70%) or lens/eyeglass cleaning wipes.



CAUTION – When cleaning the heated glass plate(s), be careful when wiping the inner surface of the lid not to damage the electro-conductive coating. Also take care not to damage the glass plate. The use of ethanol or other types of organic solvents may remove the instrument's paint.

To clean the heated components and/or the Temperature Controller switch off the ibidi Temperature Controller – Silver Line and disconnect all electrical cables. Leave the instrument to cool down for approx. 5 minutes.



WARNING – Hot surface (max. 55°C)! Do not touch Heated Lid, Heated Plate, and Heated Glass Bottom when they are hot.

7.2 Influence of Ambient Temperature and Ventilation

The ambient temperature affects the conditions inside the incubation chamber. Devices, such as computers and camera controllers, can significantly heat up small rooms. In this case, we recommend equilibrating the room temperature to the typical experimental conditions at least 2–3 hours before starting the experiment.

Ventilation can enhance the effect of temperature and humidity changes in the vicinity of the incubation chamber. In a case where the airflow (e.g., air conditioning) cannot be stopped, we recommend shielding the microscope as much as possible.

The use of an XL-Incubator and/or an objective heater minimizes those effects and helps to stabilize surrounding conditions.

8 Troubleshooting

8.1 Focus not Stable

Focus drift is detrimental for most microscopy experiments, especially long-term time-lapse experiments. Focus stability is mainly influenced by mechanical changes and temperature variations. Follow these recommendations to keep your cells in focus:

- Switch on all components (e.g., heating, gas incubation, computer, or other equipment) at least 60 minutes before starting the experiment.
- After you put the sample onto the microscope, wait 30 minutes before starting a time-lapse experiment to achieve temperature and immersion oil equilibration.¹
- Keep the room temperature as stable as possible. Air conditioning should either be in operation all the time or switched off.
- Do not change the temperature during the experiments. Avoid door/window openings, as this could rapidly change the temperature.
- Eliminate all sources of mechanical vibrations. Use a damped table for your microscope.

8.2 Evaporation too High

Depending on the incubating conditions, small volumes might evaporate quickly, especially during long-term experiments. If you have an actively controlled humidifying device (e.g., ibidi Gas Incubation System), increase the set value for relative humidity. Additionally, we suggest using silicone oil (e.g., Anti-Evaporation Oil, ibidi, 50051) to decrease evaporation.

Covering the medium with sterile silicone oil prevents all evaporation effects and is compatible with cell culture. Please do not use mineral oil, as this can be harmful to your cultureware.

Equilibrate oil and medium inside the incubator overnight. This step helps to avoid the formation of air bubbles, and pre-warms the solutions to 37 °C. Afterwards, fill your slide with cells and medium. Cover the medium's surface with an appropriate amount of silicone oil. Don't drip the oil directly onto the surface, but let it run down the edges of the cell culture vessel. Details about avoiding evaporation are given on the ibidi web site in [Application Note 12 "Avoiding Evaporation: Humidity Control in Cell Culture"](#).

8.3 Condensation Inside the Stage Top Incubator

Check the temperature of the chamber (Heated Lid and Heated Plate). In case of condensation, decrease the humidity and air-dry the incubator if necessary.

Please contact ibidi at techsupport@ibidi.com for further troubleshooting help.

¹ If the experiment needs to be started immediately, either after placing the sample on the microscope or after closing the lid, we recommend checking the focus for 20 minutes. In the first few minutes after starting the experiment, temperature equilibration might influence the focus/z-position of the cells.



ibidi GmbH

Lochhamer Schlag 11
82166 Gräfelfing
Germany

Toll free within Germany:

Phone: 0800/00 11 11 28
Fax: 0800/00 11 11 29

International calls:

Phone: +49 89/520 46 17 - 0
Fax: +49 89/520 46 17 - 59

E-Mail: info@ibidi.com
ibidi.com

